

/CREATING WETROOMS



seamless walk-in showering



Creating wetrooms long-lasting satisfaction

Create your own seamless wetroom for **relaxing and invigorating showering** with a sense of space and freedom. And do so, knowing that the products you've used to build your perfect wetroom are tried, tested, and assured to give **trouble-free performance** for years to come.

The products in this catalogue represent **specialist products**, developed specifically for wetroom applications. Boasting both design ingenuity and production quality, they make creation of a dependable and luxurious wetroom **straightforward and cost-effective**.

Enjoy contemporary design, modern convenience, and best of all a dash of personal self-indulgence.

Walk in – it's your shower.



Contents

building your wetroom

Kaskade Shower Bases

6

Mobility Wetroom Applications

8

Kaskade Shower Traps

9

Tile Backer Board

10

Wetroom Preparation

12

Sealants & Adhesives

13

Wetroom Kits

16

Shower Screens

18

Installation -
Kaskade shower bases

21

FAQs

30

Product Information

31

Kaskade Shower Base



Available in 3 sizes, Kaskade one-piece shower bases fit flush with the floor, ready for tiling over. A built-in fall to the centre of the base, fitted with a Kaskade shower trap, ensures rapid drainage to keep up with the most powerful of showers. The rebated base edge accepts 6mm 'NO MORE PLY' tile backer boards, creating a watertight seal to the adjoining surfaces.

- / One-piece, pre-formed shower bases
- / Shower base sizes: 1000mm x 1000mm, 1200mm x 900mm or 1500mm x 800mm
- / 25 year guarantee on Kaskade shower bases
- / Adjoining backer boards slot into rebated edge, creating a watertight seal
- / Built-in fall ensures rapid drainage
- / Ideal for concrete floors
- / Special versions available for soft floor covering applications

Installation instructions for Kaskade trays on pages 21-29.

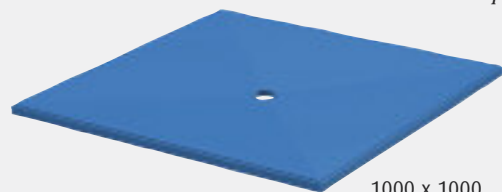

1000 x 1000

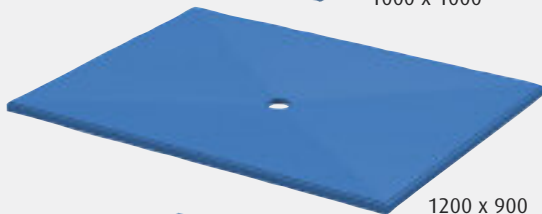

1200 x 900

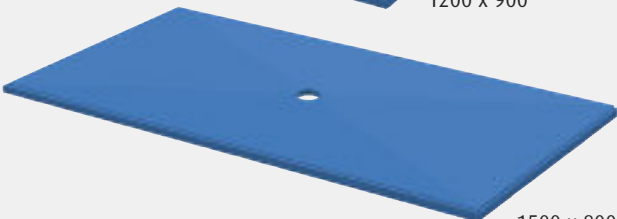

1500 x 800

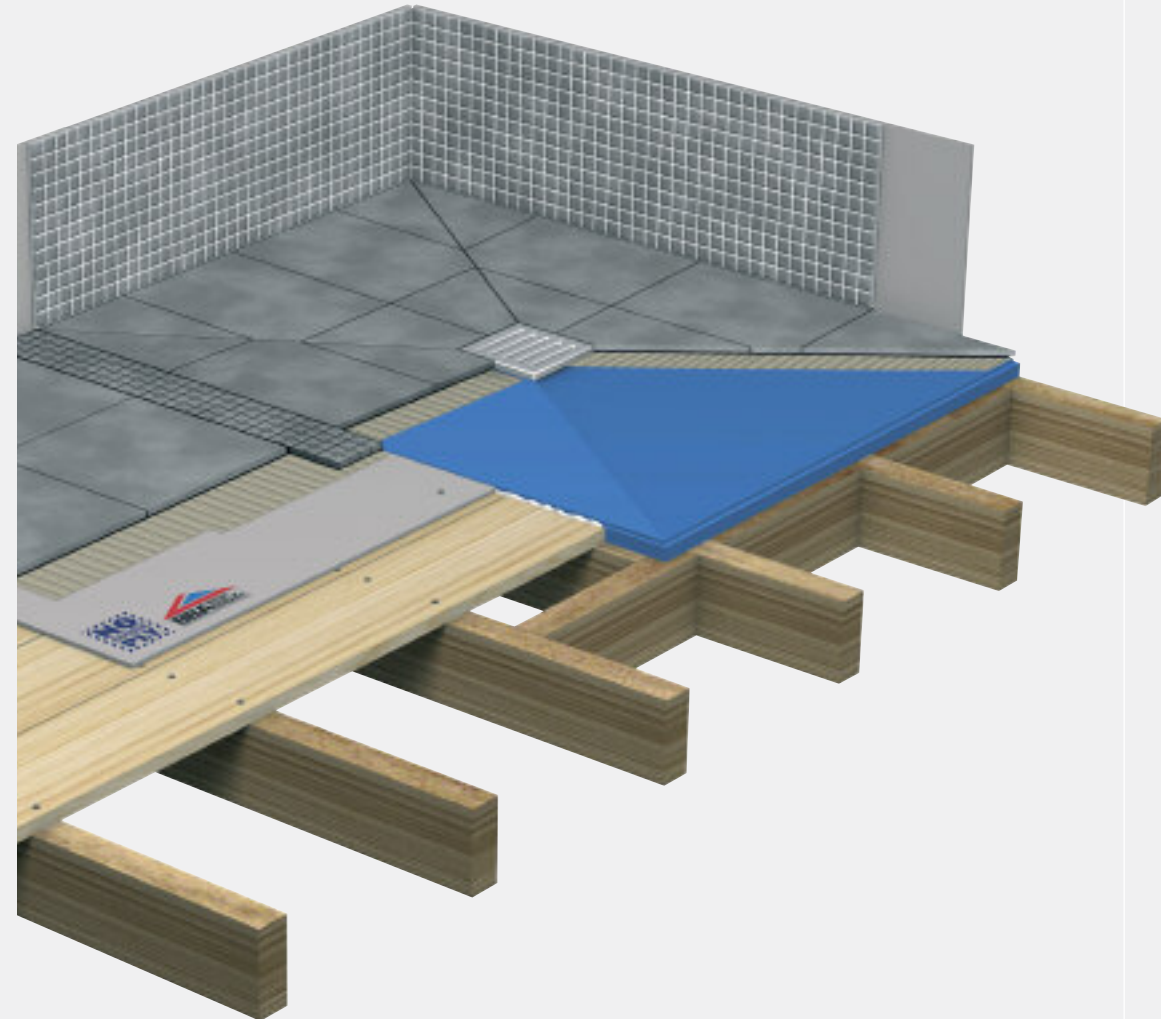

Kaskade[®]
THE WET-ROOM SHOWER TRAY

Kaskade Mobility Wetroom Applications

Kaskade shower trays can be combined with non-slip vinyl flooring and round Kaskade traps, to create the perfect mobility wetroom with a sense of safety and space. Eliminating awkward steps and offering exceptional ease of cleaning, Kaskade is the long-awaited answer to all mobility requirements in the wetroom. Simply specify a Kaskade shower base and trap for soft floor covering applications.

- / All the Kaskade Shower Base properties detailed on page 6
- / Specialist bases suitable for covering with soft flooring
- / Round Kaskade trap with stainless steel grate suitable for wheelchair surmounting



Kaskade Shower Trap

Flexible and compact, the Kaskade shower trap is a high-performance, German made trap, offering exceptional ease of installation and outstanding fast-flow drainage. Small enough to sit within the height of a floor-joist, and with top access for easy cleaning, the Kaskade trap suits every application. A choice of designer grates are available, at extra cost, to complement your completed wetroom.

- / High-performance, German made shower traps
- / Compact 80mm depth, with adjustable exit for easy installation
- / Fast-flow drainage up to 40 litres per minute
- / Standard stainless steel grate or a choice of designer grates at extra cost
- / Top access for easy cleaning
- / Extension pieces and vertical traps available
- / Special traps available to fit soft floor covering type Kaskade shower bases

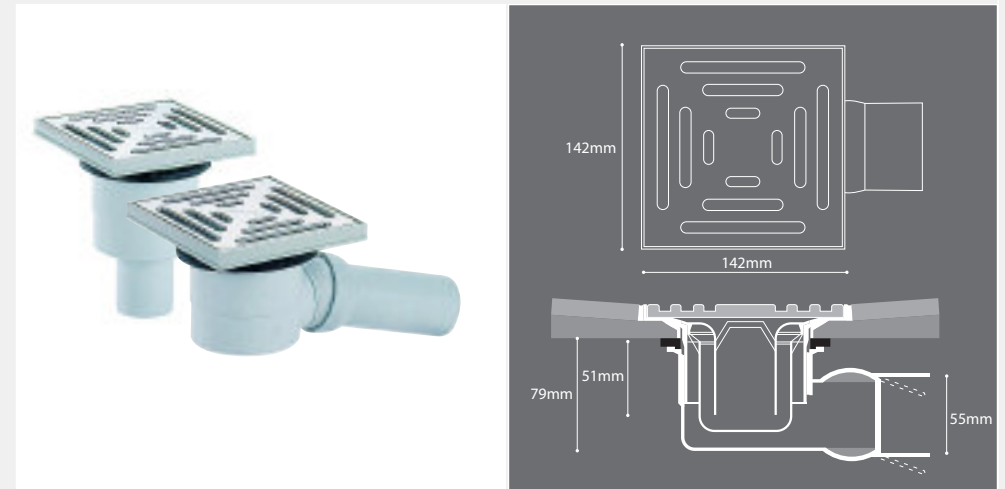

NO MORE PLY



Built for the purpose, NO MORE PLY tile backer board is the best material to line your wetroom walls and floors before tiling. Easy to handle, cut, and lay, NO MORE PLY offers superior moisture, impact and heat resistance, enabling it to stand up to the demands of the wetroom environment. Its slimline 6mm thickness prevents unwanted build up to floors.

- / Specialist material for preparing walls and floors for tiling
- / Supplied in 1200 x 600 x 6mm sheets for minimum build up, or 1200 x 900 x 9mm sheets that are excellent for timber stud walls
- / Outstanding resistance to moisture, heat and impact damage
- / Prime with Mega SBR Tilers Primer for total waterproofing
- / Seal and reinforce the joints and corners with Mega Strength Adhesive for guaranteed no leaks
- / BBA approval - install with confidence
- / 25 year guarantee



Green-Label product

Visit www.nomoreply.net for more details and downloads



Moisture-proof
Dimensionally stable, unaffected by moisture absorption. The perfect substrate for all tiles in bathrooms and kitchens. Ideal for wet rooms. For total waterproofing use SBR Primer.



Impact resistant
Minimal damage during transportation, handling, storing and laying - excellent for all busy sites.

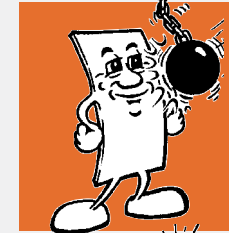

Heat resistant
Ideal for use under Thermonet and most other electrical underfloor heating systems.

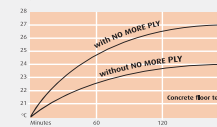

Thin
Only 6mm is added to the floor height when overboarding timber floors.

Two board sizes available:
1200 x 600 x 6mm
1200 x 900 x 9mm.

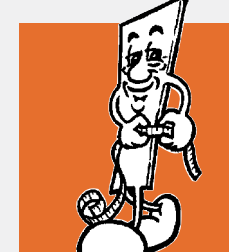

Easy to handle
Handy 1200 x 600 x 6mm size. Will fit into most small cars and vans. Always store flat.

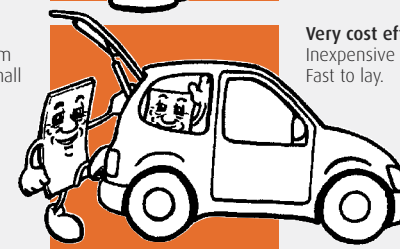

Incombustible
Contains no asbestos and will not burn.



Noise reducing
Good sound proofing characteristics make it ideal for overboarding in apartments.



Easy to cut
Most cuts can be done simply with the NO MORE PLY Scoring Knife. For awkward shapes use a jigsaw with a tungsten blade.

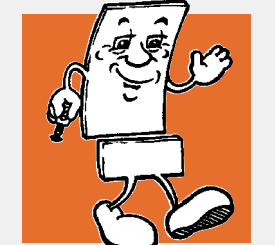

Easy to fix
8 x NO MORE PLY screws per sheet and a small amount of NO MORE PLY Mega Strength Polyurethane Adhesive and it's fixed!



Very cost effective
Inexpensive to buy. Fast to lay.

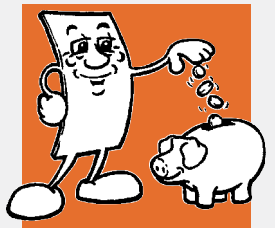

Wetroom Preparation and Waterproofing

To prepare for your ideal wetroom, simply use the right products at the right time. Mega products make preparation and waterproofing straightforward and effective, and ensure that your wetroom is as enduring as it is enjoyable.

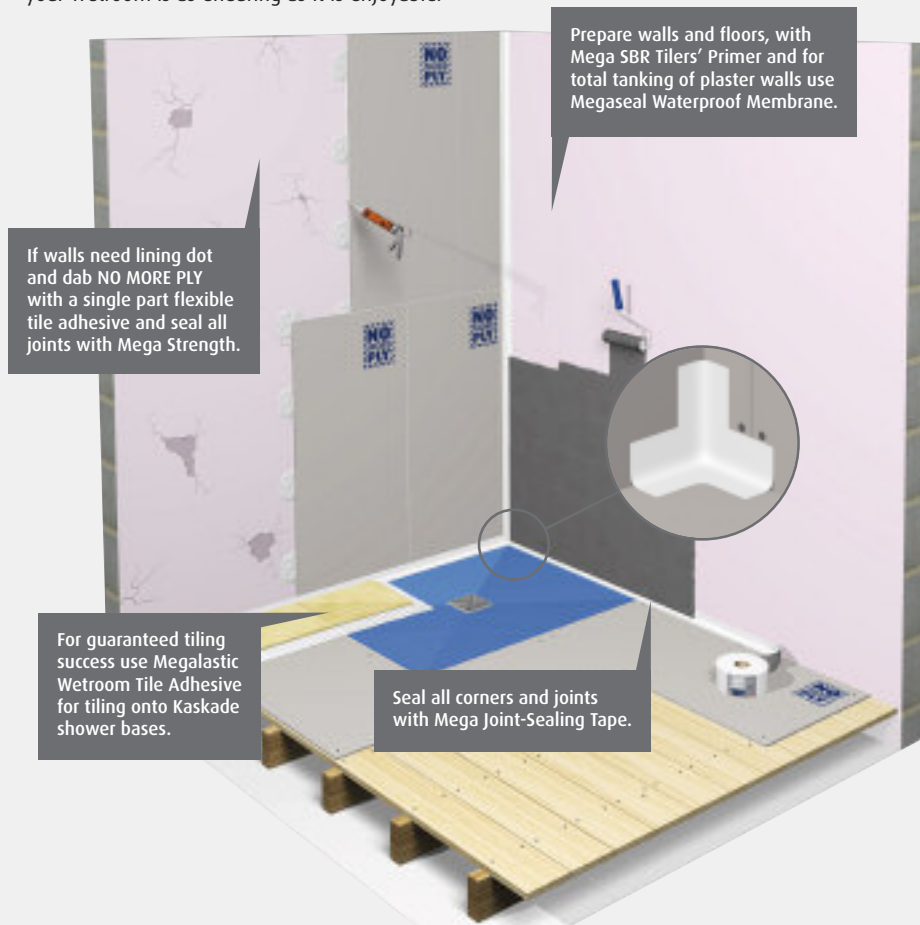

Mega Strength Adhesive 310ml

Mega Strength is a fast-setting, waterproof adhesive, which boasts versatility and great strength. Designed specifically to bond NO MORE PLY tile backer boards to wood, metal, brick, stone or concrete, it can also be used in many other applications, including waterproofing and reinforcing of all types of joints. Application is very straightforward with a standard sealant gun.

- / Polyurethane adhesive for waterproof bonding
- / Fast setting – bonded joints can be handled within 5-10 minutes
- / Exceptional high-bond strength
- / Foams slightly on application to fill small gaps and increase adhesion strength
- / Conforms to EN204(d4)
- / 1000's of uses

Order Code: **5620**



Mega Power Sealant 310ml

Based on advanced technology, Mega Power sealant will bond and seal virtually anything to everything! Providing a long-lasting, totally waterproof finish, Mega Power is perfect for every bonding and sealing requirement in your wetroom, where a fast setting time is not required. It is easy to apply, and provides a clean white finish.

- / Adhesive sealant for waterproof bonding and sealing
- / Maximum strength and versatility
- / Sets within 24-48 hours
- / Easy application with a standard sealant gun
- / Clean white finish
- / New crystal clear mega power sealant available

Order Code: **5622**



Mega SBR Tilers Primer 1L



Mega SBR is a highly-effective latex primer for preparing wetroom floors and walls for tiling. As well as waterproofing, Mega SBR also has a bonding quality that stabilizes the surfaces to which it is applied, ensuring optimum tiling conditions and long-lasting wetroom durability.

- / Water-based wetroom primer for preparing walls and floors
- / Waterproofs and stabilizes surfaces
- / Quick and easy to apply
- / Ensures ideal tiling conditions

Order Code: **3019**

Megaseal Waterproof Membrane 5kg



Megaseal is a heavy-duty tanking membrane, providing a 100% watertight seal that is clearly visible when applied. Drying to a thick, grey membrane, its elastic property allows for movement in walls and floors, but bonds any loose-surface elements to a stable finish ready for tiling.

Not just for wetrooms! Megaseal is an extremely versatile material and can be used as a damp proof membrane in many situations such as garage and shed walls and for tanking out basements.

- / Heavy-duty tanking membrane
- / Quick and easy-to-apply liquid compound
- / Suitable for use with underfloor heating
- / Elastic formula for a watertight seal
- / Coverage: 0.9kg/m²

Order Code: **5847**

Mega Joint-Sealing Tape 80mm x 10m

Providing highly-effective sealing of corners and joints, Mega Joint-Sealing Tape is a robust and totally water-resistant material. Its flexible construction and self-adhesive property makes it easy to apply and helps to ensure that a fully waterproof finish is achieved in the wetroom.

- / Robust waterproof tape
- / Effective sealing of joints and corners
- / Self-adhesive for easy application
- / Flexible construction
- / Lip onto baths for extra protection from water penetration

Order Code: **5848**



Megalastic Wetroom Tile Adhesive 5kg

Offering exceptional strength and water-resistance, Megalastic is a professional adhesive for wetroom tiling, suitable for use with underfloor heating. Based on advanced technology, the 2-part construction cures to a clean white finish, and provides a waterproof membrane to the walls and floors to which it is applied.

- / Professional wetroom tile adhesive that outperforms conventional adhesives
- / 2-part construction that cures to a clean white finish
- / Exceptional strength of bond
- / Outstanding water-resistance
- / Suitable for use with underfloor heating

Order Code: **5621**



Wetroom Kits

Making it easy to create the ideal wetroom, these kits provide you with all you need to establish your shower base and prepare for tiling around. Extra Mega products are available for tiling and completing your wetroom.

3m² Wetroom Kit

Includes: Kaskade shower base with trap, 1200 x 900mm or 1000 x 1000mm; 3 x 6mm NO MORE PLY tile-backer boards; 2 x Mega Strength Adhesive; 1 x Mega SBR Tilers Primer (1L); 1 x NO MORE PLY Screws; 1 x NO MORE PLY Scoring Knife, 5 metres of Mega Tape, 5kg of Megalastic Wet Room Tile Adhesive and 'Creating Wetrooms' Instruction Manual.

6m² Wetroom Kit

Includes: Kaskade shower base with trap, 1200 x 900mm or 1000 x 1000mm; 8 x 6mm NO MORE PLY tile-backer boards; 3 x Mega Strength Adhesive; 1 x Mega SBR Tilers Primer (1L); 1 x NO MORE PLY Screws; 1 x NO MORE PLY Scoring Knife, 5 metres of Mega Tape, 5kg of Megalastic Wet Room Tile Adhesive and 'Creating Wetrooms' Instruction Manual.

12m² Wetroom Kit

Includes: Kaskade shower base with trap, 1200 x 900mm or 1000 x 1000mm; 16 x 6mm NO MORE PLY tile-backer boards; 4 x Mega Strength Adhesive; 1 x Mega SBR Tilers Primer (1L); 1 x NO MORE PLY Screws; 1 x NO MORE PLY Scoring Knife, 5 metres of Mega Tape, 5kg of Megalastic Wet Room Tile Adhesive and 'Creating Wetrooms' Instruction Manual.

Option of 1500 x 800mm shower base available with all kits.

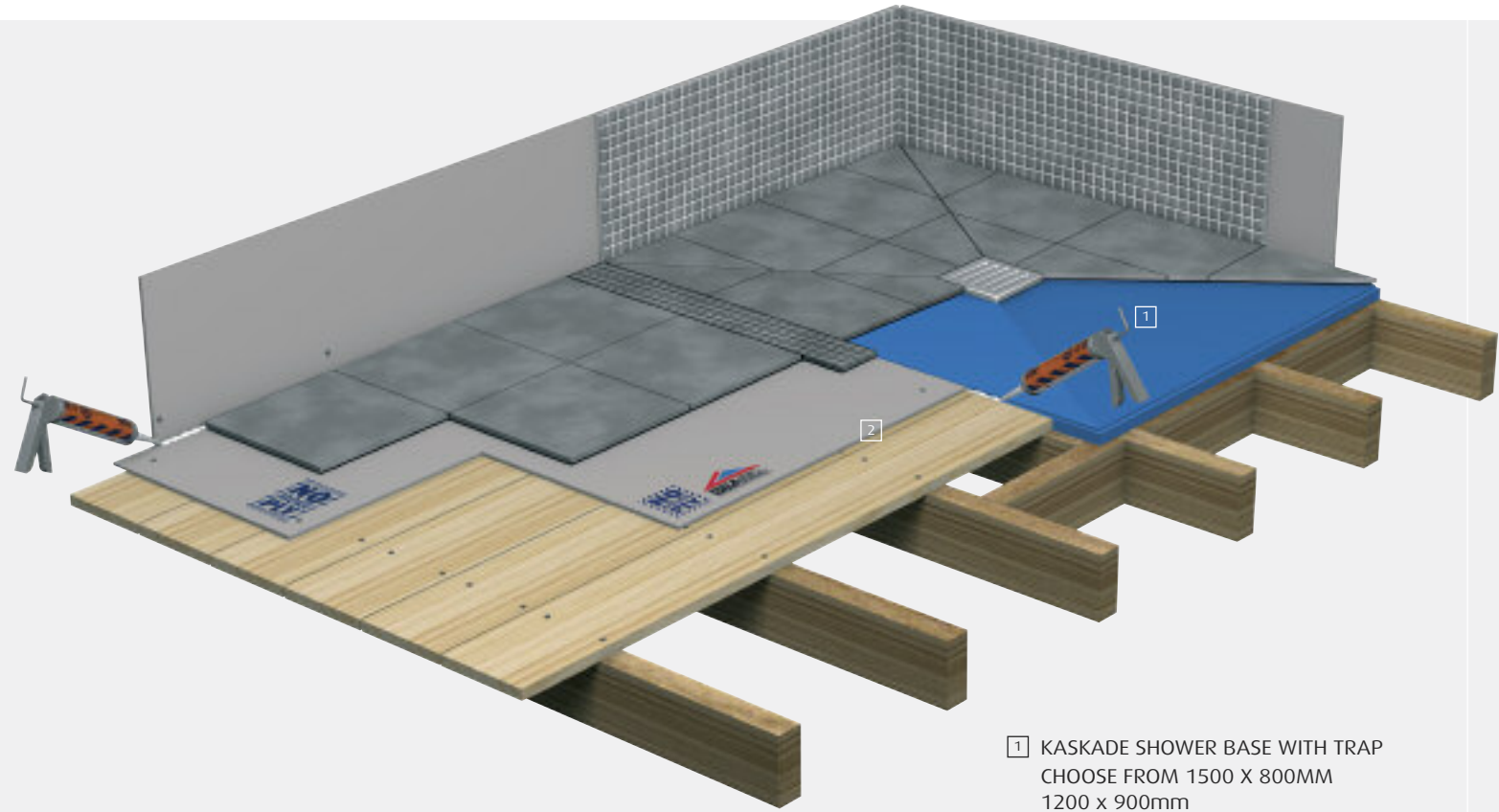

- 1 KASKADE SHOWER BASE WITH TRAP
CHOOSE FROM 1500 X 800MM
1200 X 900MM
OR 1000 X 1000MM
- 2 NO MORE PLY BACKER BOARD
- 3 MEGALASTIC WET ROOM TILE ADHESIVE
- 4 MEGA STRENGTH ADHESIVE
- 5 CREATING WETROOMS BOOKLET
- 6 CARBIDE TIPPED SCORING KNIFE
- 7 SBR TILERS PRIMER
- 8 NO MORE PLY SCREWS
- 9 MEGA JOINT SEALING TAPE

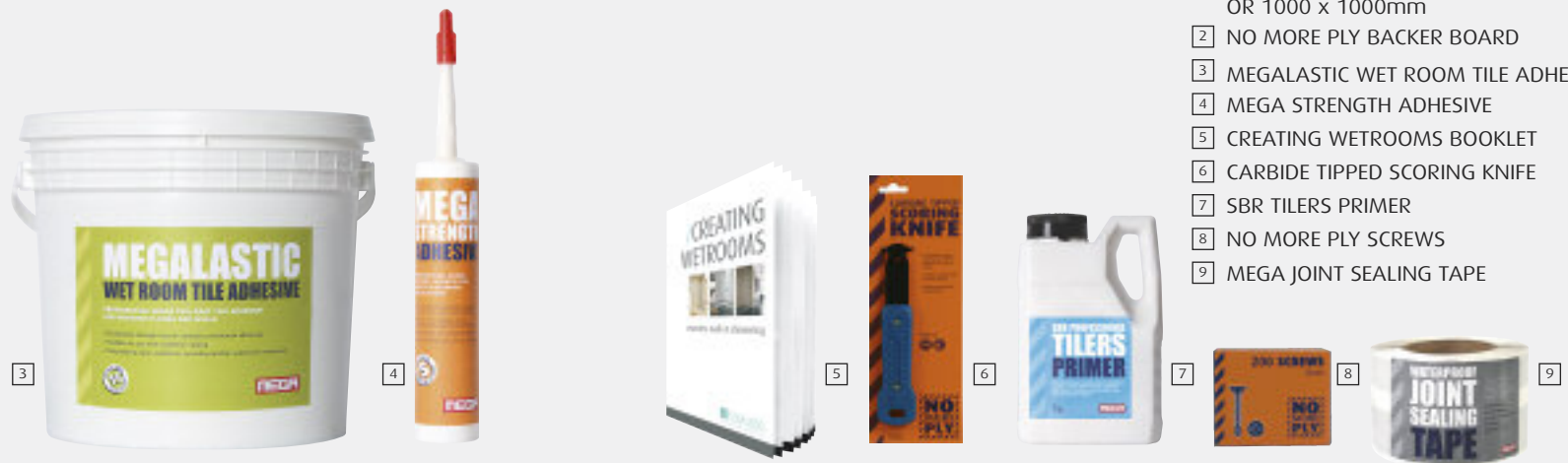



Configuration suggestions:

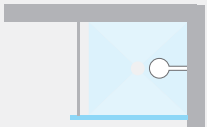
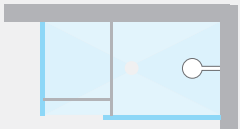
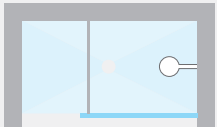
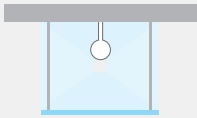

Novex Glass Screens

Providing contemporary style with traditional practicality, Novex glass shower screens maintain the spacious feel and ease of cleaning that Kaskade wetrooms are known for. Supplied with chrome support arms for single or two sided screen arrangements, all four screen sizes are rigid and strong when installed. Seal to floor with clear Mega Power Seal.

- / Glass shower screens with chrome support arms
- / Screen sizes 2000mm high and 1200/1000/900/700mm widths (see page 2)
- / 6mm glass thickness for wall fixed panels
- / 8mm glass thickness for walk through panels, 1200mm wide only (pictured above)
- / Single arm for single screens; T-shaped arms for front and side panels
- / Practical and very hygienic



Create an en-suite shower room that you thought you never had space for!

Novex Double Pivot Glass Screens

Providing maximum practicality, the functional Pivot shower screen is both space saving and good looking. The rise and fall hinge action enables the screen to maintain its position whilst the shower is being used but can be conveniently folded out for easier access, or folded in to save space in confined wetroom areas.

- / Glass shower screen with pivot hinge
- / Rise and fall hinge action
- / 6mm glass thickness
- / 1850mm high and 760/900mm widths
- / Space saving practicality
- / Ideal for mobility access situations
- / Concealed fixing covers
- / Chrome hinge and handles

Pivot door for...

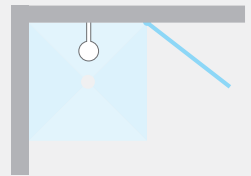

...easy access,

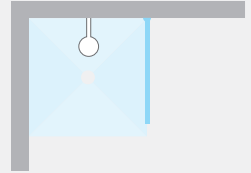

...showering and

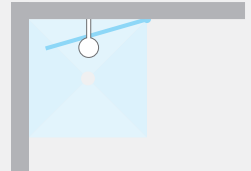

...saving space - so you've plenty of room to get dried and dressed!

Create your own bespoke wetroom screen



Channel Glaze



Channel Glaze enables you to create a stunning bespoke shower screen to exactly the size you require. Finely-engineered channel with a polished chrome finish adds distinction to your shower area, and provides firm floor and wall support for 8mm toughened-glass screens. The rebated and grooved edge ensures a strong concealed bond to adjoining tiles or any other surface.

- / Polished-chrome channel supplied in 2m lengths
- / Grooved surface to rebated edge ensures firm bond with adjoining surfaces



Actual size



Installing a Kaskade shower base into a timber floor

The Kaskade wetroom system is designed to fit quickly and easily into traditional timber floors. The compact shower trap will sit within the depth of standard floor joists, and the depth of the shower base combines perfectly with standard 22mm floorboards. The following instructions show just how simply a Kaskade system can be installed on to your timber floor, to provide you with wetroom comfort and ease.

- A** Cut out floorboards to the size of the shower base.



- B** Put trap and waste into position, and support with timber to the correct height; black rubber seal of the trap should be 22mm below existing floor level.





C Fix noggings or extra joists where required, to provide support to all edges of the shower base as well as closely around the outlet. Use Mega Strength adhesive to ensure a firm fix for noggings.

F Remove shower base and run a bead of Mega Strength on each joist and nogging. Replace shower base and fix down using No.8 screws, filling screw holes with Mega Strength adhesive for a watertight seal. **DO NOT OVERTIGHTEN.** WARNING: Mega Strength is a permanent glue; the shower base will not be removable once fixed. Seal between the base and the wall with Mega Strength (the rebate against the wall will be filled with tile adhesive when tiling)

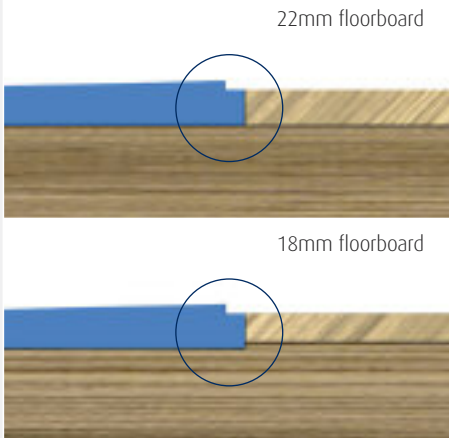

D To allow for overboarding a floor with 6mm NO MORE PLY, the top edge of the shower base has been designed to sit 6mm proud of a 22mm floorboard floor. If installing into an 18mm floorboard floor, the joists will need to be routed by 4mm to allow the rebated edge of the base to sit flush with the floor.

G Assemble and install the remaining parts of the trap, and use the temporary plastic cover to protect the trap during tiling.

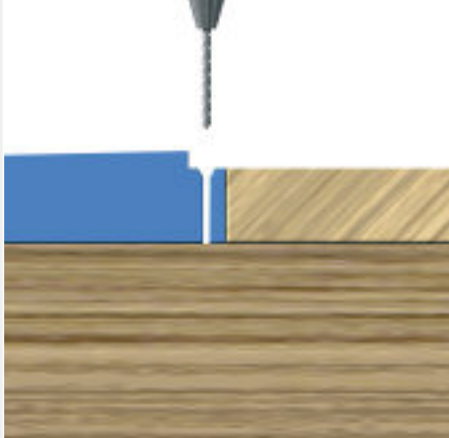

E Test the base and trap positions to make sure the outlet lines up with the trap. Drill 6mm pilot holes down through the rebated edge of the shower base, without drilling into the joists, and countersink the holes.

H You can now overlay the floor with NO MORE PLY, overlapping the NO MORE PLY boards on to the rebated edge of the shower base, having first applied a good bead of Mega Strength to get a perfect seal. See separate installation instructions for fixing NO MORE PLY.

Please note: Always use Megalastic Wetroom Tile Adhesive for tiling over your Kaskade Shower base. Always use a good quality flexible grout or epoxy grout.



Installing a Kaskade shower base into an existing concrete floor

The Kaskade wetroom system can be simply and effectively integrated into any existing concrete floor, or set into newly laid concrete floors with insulation. The following instructions show how easily both options can be achieved, to incorporate your shower area within your wetroom and provide the relaxation and convenience you desire.

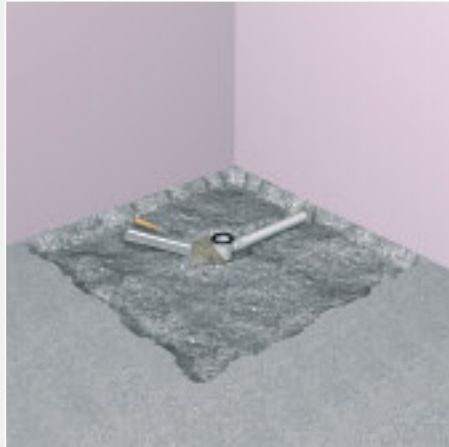

Please ensure that you purchase a Concrete Floor Fixing Kit which includes 4 stainless steel anchors, a rubber strip and a tube of Mega Power Sealant.

- A** Cut out concrete floor to the size of the shower base, plus an extra 100mm in both directions. Depth of cut-out should be approximately 40mm. Cut out deeper recess for the trap and waste; black rubber seal of the trap should be 28mm below existing floor level. Put the trap and waste into position and fill round with a weak sand and cement mix.



- B** Lay a level bed of fast-setting concrete into the whole cut-out area, ensuring that it is 32mm below the existing floor level.

- C** Drill two 6mm holes into both outside edges of the shower base, and carefully screw in the four stainless steel anchors.



- D** Stick the temporary 6mm rubber strip into the rebate of the room-facing edges of the shower base.

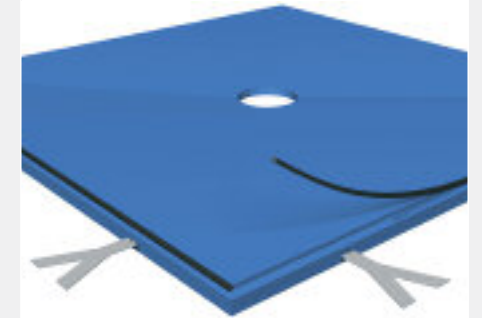

- E** Prime the concrete and then apply a bed of good quality flexible tile adhesive to the new concrete bed. Set the shower base on to the adhesive, ensuring that the top is flush with the existing floor level and that a 3mm gap is left between the shower base and the walls. Assemble and install remaining parts of the trap.

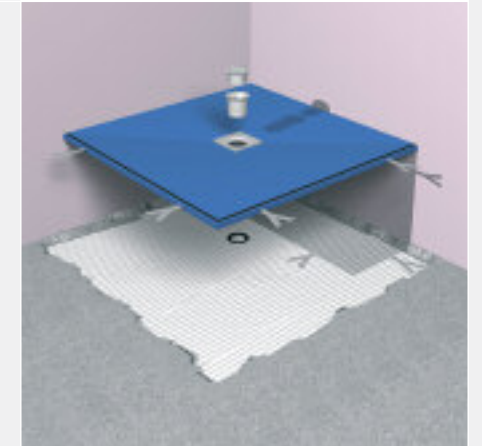

Installing a Kaskade shower base onto a new concrete floor

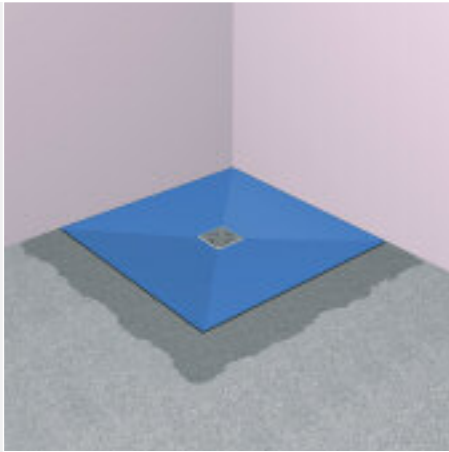

F Fill void around the shower base with screed.



G When the screed is set, remove rubber protection strip and fill the gap with Mega Power, as well as gaps between the shower base and the walls. If tiling over Kaskade, prime the surrounding concrete before tiling with two coats of Mega Primer SBR, diluted 3:1, to fully waterproof it.

Please note: Always use Megalastic Wetroom Tile Adhesive for tiling over your Kaskade Shower base. Always use a good quality flexible grout or epoxy grout.

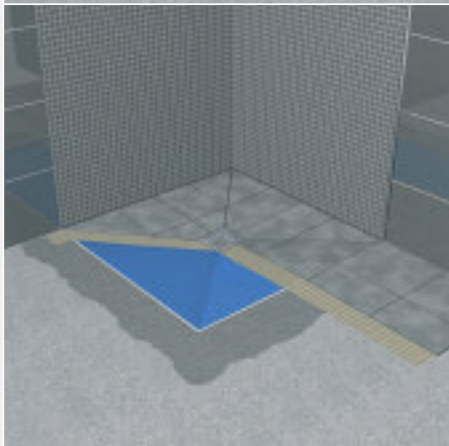

H Always wait until all new screed is fully cured before laying any floor covering.

A Stick down insulation sheets on to the floor with Mega Strength or Mega Power. Cut out for waste and trap.



B Put trap and waste into position; **the black rubber seal of the trap should be 28mm below the finished floor level**, the trap may require recessing into the existing concrete floor. Put the trap and waste into position and fill round with a weak sand and cement mix.

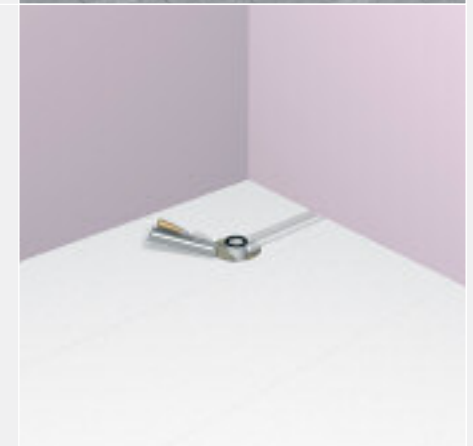



C Lay a level bed of fast-setting concrete around the trap to the size of the shower base, plus an extra 100mm in both directions, ensuring that the finished level is 32mm below the final floor level. Alternatively lay a pad of Beava Board to achieve the correct height. Beava Board is available in 7 thicknesses 5.5, 10, 12, 20, 30, 40 and 50mm (order separately).

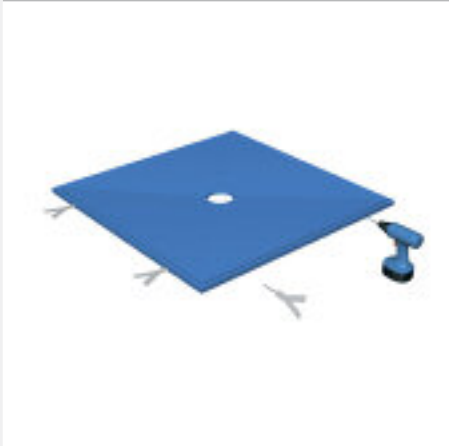

D Drill two 6mm holes into both outside edges of the shower base, and carefully screw in the four stainless steel anchors.

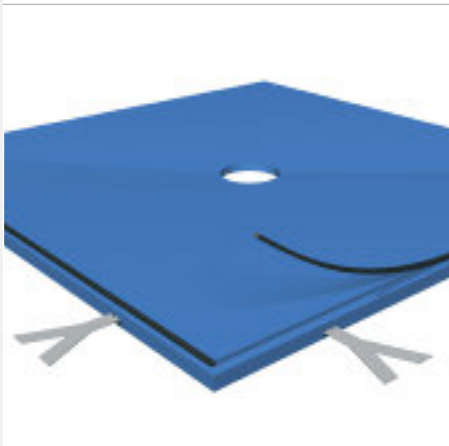

E Stick the temporary 6mm rubber strip into the rebate of the room-facing edges of the shower base.

F Apply a bed of good quality flexible tile adhesive to the new concrete bed and set the shower base on to the adhesive, ensuring that the top is flush with the final floor level and that a 3mm gap is left between the shower base and the walls. Assemble and install remaining parts of the trap. The surrounding floor can now be screeded.

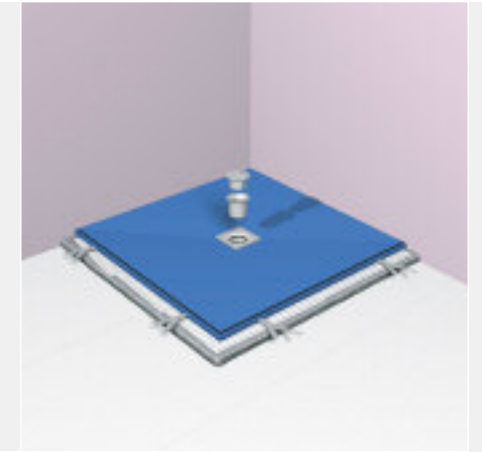

G When the screed is set, remove rubber protection strip and fill the gap with Mega Power, as well as gaps between the shower base and the walls. If tiling over Kaskade, prime the surrounding concrete before tiling with two coats of Mega Primer SBR, diluted 3:1, to fully waterproof it.

Please note: Always use Megalastic Wetroom Tile Adhesive for tiling over your Kaskade Shower base. Always use a good quality flexible grout or epoxy grout.

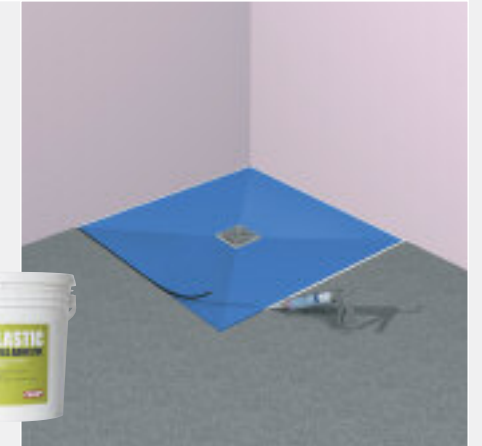

H Always wait until all new screed is fully cured before laying any floor covering.

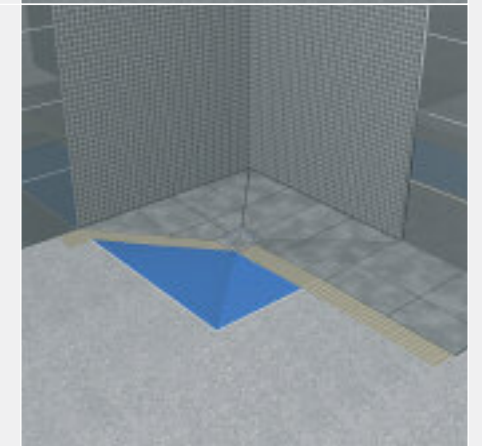

Here are the most frequently asked questions

Q Can the Kaskade shower tray be cut down?

A Yes it can. Make sure the installer pays attention to the fall when tiling the reduced side.

Q Does the Kaskade shower tray come with a trap and grate?

A Yes it does. Kaskade is supplied complete with a top quality fast-flow German made trap with an attractive, easily removable stainless steel grate. This facilitates easy cleaning of the trap. Trap capacity is 40L per minute.

Q How much space does the trap take?

A Only 80mm space is needed under the floorboards. A vertical outlet is also available.

Q Why choose Kaskade?

A Kaskade shower trays are simple to install and, when used with NO MORE PLY, create a problem free wetroom without a step. With endless design possibilities in wetrooms it is perfect for the modern bathroom.

Q I'm interested, what do I do now?

A Discuss your room plan with your stockist. They will work out what you need. If you don't know who your nearest stockist is or for further information call the Kaskade and NO MORE PLY helpline on 0800 0015 092.

Wet Room Product Codes

SHOWER BASES

Product description	Product Code
Kaskade 1200x900mm for tiled floors (inc. trap and waste)	5805
Kaskade 1000x1000mm for tiled floors (inc. trap and waste)	5800
Kaskade 1500x800mm for tiled floors (inc. trap and waste)	5803
Kaskade 1200x900mm for soft floors (inc. trap and waste)	5807
Kaskade 1000x1000mm for soft floors (inc. trap and waste)	5806
Prefix stock code with V if vertical trap is required	
Concrete fixing kit	5808

SHOWER SCREENS / SYSTEMS

Novex Screen 1200mm wide x 2m high	5810
Novex Screen 1000mm wide x 2m high	5811
Novex Screen 900mm wide x 2m high	5812
Novex Screen 700mm wide x 2m high	5813
Shower screen enclosure support kit	5814
Channel Glaze 2m lengths	5886
Novex Walk Through Glass Screen 1200mm wide x 2m high	5816
Novex Double Pivot Glass Screen 760mm wide x 1850mm high	5819
Novex Double Pivot Glass Screen 900mm wide x 1850mm high	5818

TILE-BACKER BOARD

NO MORE PLY 1200x600x6mm	5600
NO MORE PLY 1200x900x9mm	5700

CONSUMABLES

Mega Strength Adhesive	5620
Megalastic Wetroom Tile Adhesive	5621
Mega Power Sealant	5622
Mega SBR Tilers Primer	3019
Megaseal Liquid Waterproof Membrane	5847
Mega Joint-Sealing Tape	5848

WET ROOM KITS

3m ² - Kaskade wet room kit	5855
6m ² - Kaskade wet room kit	5856
12m ² - Kaskade wet room kit	5857

Safety First:



Installation Notice:

These instructions are for guidance only. As conditions of use and any labour involved are beyond our control the end user must satisfy himself by prior testing that the product is suitable for his specific application. No responsibility can be accepted or any warranty given by our representatives, agents or distributors.

Guarantee Terms:

The Kaskade twenty five year guarantee only applies when correct installation procedures, as set out in this booklet, have been followed.

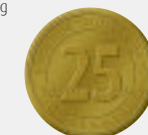

www.kaskadewetrooms.co.uk
www.nomoreply.net



/CREATING WETROOMS PRODUCT HELPLINE 0800 0015 092

Please note: This booklet is for guidance only. Full instructions on the installation and use of any of the products in this booklet are available from STS.